



INDICE

| | | |
|----|------|--|
| 3 | 5BA | - Accesorios de Baranda |
| 5 | 7AC | - Accesorios de Cierre para Practicables |
| 6 | 7BI | - Bisagras |
| 7 | 7CO | - Compases |
| 8 | 7CR | - Cremonas |
| 8 | 7KT | - Kits para Practicables (Tapas Inversoras, Oscilobatientes, Etc) |
| 9 | 7MT | - Tiradores |
| 9 | 7PA | - Pasadores |
| 10 | 7SP | - Accesorios para Puertas Acordeon |
| 10 | 7VA | - Accesorios Varios (Esquineros, Grapas Etc.) |
| 11 | 8CI | - Cierres para Correderas |
| 11 | 8KT | - Kits para Correderas |
| 12 | 8RQ | - Accesorios Correderas Series RQ |
| 13 | 8RU | - Rodamientos para Correderas |
| 13 | 9CE | - Cilindros y Cerraduras para Puertas |
| 15 | 9ES | - Escuadras y Uniones |
| 17 | 9FE | - Felpas |
| 18 | 9GO | - Gomas |
| 20 | 9PR | - Accesorios para Premarcos |
| 20 | 9TR | - Accesorios Correderas de Fachada |
| 21 | 9VA | - Accesorios Varios (Limpiadores, Rejillas, Soportes de Lamas, Etc.) |
| 21 | 9W | - Accesorios Mixta Aluminio y Madera |
| 30 | NC36 | - Mecanismos Lamas Mallorquinas |



ACCESORIOS

Los derechos de reproducción y propiedad de este catálogo pertenecen a PROVEDAL y solamente puede utilizarse o cederse con el consentimiento escrito del propietario. RESERVADOS TODOS LOS DERECHOS

| | |
|---|---------------|
|  | SERIES BAR |
| 5BA/01 X TAPON EN ALUMINIO PARA BAR/01 | LB - NE |

| | |
|---|---------------|
|  | SERIES BAR |
| 5BA/02 X TAPON EN ALUMINIO PARA BAR/08 | LB - NE |

| | |
|---|---------------|
|  | SERIES BAR |
| 5BA/03 X TAPON EN ALUMINIO PARA BAR/02 | LB - NE |

| | |
|---|---------------|
|  | SERIES BAR |
| 5BA/04 X TAPONES EN ALUMINIO 30° PARA BAR/02 | LB - NE |

| | |
|---|---------------|
|  | SERIES BAR |
| 5BA/05 X TAPONES EN ALUMINIO 30° PARA BAR/08 | LB - NE |

| | |
|---|---------------|
|  | SERIES BAR |
| 5BA/06 X TAPON EN ALUMINIO PARA BAR/03 | LB - NE |

| | |
|--|---------------|
|  | SERIES BAR |
| 5BA/07 X TAPONES EN ALUMINIO 30° PARA BAR/03 | LB - NE |

| | |
|--|---------------|
|  | SERIES BAR |
| 5BA/08 X TAPONES EN ALUMINIO 30° PARA BAR/01 | LB - NE |

| | |
|--|---------------|
|  | SERIES BAR |
| 5BA/09 ESCUADRAS ALINEAMIENTO 30° | |

| | |
|---|---------------|
|  | SERIES BAR |
| 5BA/10 TORNILLO INOX PARA FIJAR 5BA/11 | |

| | |
|---|---------------|
|  | SERIES BAR |
| 5BA/11 X ESQUINA DE 90° PARA BAR/02 | LB - NE |

| | |
|---|---------------|
|  | SERIES BAR |
| 5BA/12 ESCUADRA FIJA PARA ANGULO DE 90° | |

| | |
|---|---------------|
|  | SERIES BAR |
| 5BA/13 ESCUADRA EN ANGULO VARIABLE | |

| | |
|---|---------------|
|  | SERIES BAR |
| 5BA/14 ESCUADRA A COMPAS | |

| | |
|---|---------------|
|  | SERIES BAR |
| 5BA/15 ESCUADRA EN ANGULO REGULABLE | |

| | |
|---|---------------|
|  | SERIES BAR |
| 5BA/16 ESCUADRA EN ANGULO REGULABLE Y A DOBLE NUDO | |

| | |
|---|---------------|
|  | SERIES BAR |
| 5BA/17 X SOPORTE FIJACION PASAMANO A MURO | LB - NE |

| | |
|---|---------------|
|  | SERIES BAR |
| 5BA/18 X TERMINAL INFERIOR IZQUIERDO PARA BAR/21 | LB - NE |



ACCESORIOS

| | | | | | |
|--|---------------|--|---------------|---|---------------|
| | SERIES BAR | | SERIES BAR | | SERIES BAR |
| 5BA/19 X PIEZA INFERIOR CENTRAL PARA BAR/21 | LB - NE | 5BA/20 X TERMINAL INFERIOR DERECHO PARA BAR/21 | LB - NE | 5BA/21 X TERMINAL ALTO IZQUIERDO A 30° PARA BAR/21 | LB - NE |
| | SERIES BAR | | SERIES BAR | | SERIES BAR |
| 5BA/22 X TERMINAL ALTO DERECHO A 30° PARA BAR/21 | LB - NE | 5BA/23 X TERMINAL CENTRAL IZQUIERDO A 30° PARA BAR/21 | LB - NE | 5BA/24 X TERMINAL CENTRAL DERECHO A 30° PARA BAR/21 | LB - NE |
| | SERIES BAR | | SERIES BAR | | SERIES BAR |
| 5BA/25 X TERMINAL BAJO IZQUIERDO A 30° PARA BAR/21 | LB - NE | 5BA/26 X TERMINAL BAJO DERECHO A 30° PARA BAR/21 | LB - NE | 5BA/27 X CONJUNTO SOPORTE JUNQUILLO | LB - NE |
| | SERIES BAR | | SERIES BAR | | SERIES BAR |
| 5BA/28 X SOPORTE DOBLE PARA JUNQUILLO TERMINAL | LB - NE | 5BA/29 X CONJUNTO SOPORTE PARA JUNQUILLO A 30° IZQUIERDO | LB - NE | 5BA/30 X CONJUNTO SOPORTE PARA JUNQUILLO A 30° DERECHO | LB - NE |
| | SERIES BAR | | SERIES BAR | | SERIES BAR |
| 5BA/31 X CONJUNTO SOPORTE DOBLE TERMINAL PARA JUNQUILLO A 30° IZQUIERDO | LB - NE | 5BA/32 X CONJUNTO SOPORTE DOBLE TERMINAL PARA JUNQUILLO A 30° DERECHO | LB - NE | 5BA/33 X KIT SOPORTE JUNQUILLO A 45° | LB - NE |
| | SERIES BAR | | SERIES BAR | | SERIES BAR |
| 5BA/34 X ANCLAJE A PAVIMENTO CON MONTANTE A FUERA DE BORDE | LB - NE | 5BA/35 X ANCLAJE A PAVIMENTO | LB - NE | 5BA/36 ESCUADRA 90° PARA JUNQUILLO | LB - NE |



ACCESORIOS

Los derechos de reproducción y propiedad de este catálogo pertenecen a PROVEDAL y solamente puede utilizarse o cederse con el consentimiento escrito del propietario. RESERVADOS TODOS LOS DERECHOS

| | | | | | |
|---|--|--|--|---|--|
| | SERIES BAR | | SERIES BAR | | SERIES BAR |
| 5BA/37 ESCUADRA A 30° PARA JUNQUILLO | | 5BA/38 PIEZA UNION CON VERTICALES | | 5BA/39 PIEZA DE FIJACION CON INCLINACION | |
| | SERIES BAR | | SERIES BAR | | SERIES BAR |
| 5BA/40 PIEZA UNION PASAMANOS | | 5BA/41 X LB - NE TOPE PARA TUBO 40 X 20 | | 5BA/42 X LB - NE ANCLAJE FORJADO BASE | |
| | SERIES BAR | | SERIES BAR | | SERIES BAR |
| 5BA/43 X LB - NE TAPA PARA ANCLAJE 5BA/42 | | 5BA/44 X LB - NE UNION PASAMANO BAR/01 | | 5BA/45 X LB - NE UNION PASAMANOS BAR/03 | |
| | SERIES BAR | | SERIES BAR | | SERIES BAR |
| 5BA/46 ESCUADRA PERFIL BAR/33 | | 5BA/47 X LB - NE SOPORTE VIDRIO VERTICAL | | 5BA/48 GOMA CRISTAL | |
| | SERIES BAR | | SERIES BAR | | SERIES BAR |
| 5BA/49 X LB - NE SOPORTE ANGULO VARIABLE | | 5BA/50 X LB - NE TAPON EN ALUMINIO PARA PASAMANO BAR/01 | | 5BA/51 X LB - NE TERMINAL PARA FIJAR A MURO | |
| | SERIES ALL5 CB40 CB45 RT45 RT65 | | SERIES ALL5 CB40 CB45 RT45 RT65 | | SERIES ALL5 CB40 CB45 RT45 RT65 |
| 7AC/01 RETENEDOR DE 2ª HOJA PRACTICABLE | | 7AC/02 CIERRE PARA HOJA VASCULANTE | | 7AC/13 CERRADERO PLACA (INOX) | |



ACCESORIOS

| | | | | | |
|--|--|--|--|--|--|
| | SERIES ALL5 | | SERIES CB40 CB45 RT45 RT65 | | SERIES ALL5 P400 EPOK |
| 7AC/14 ANTIPALANCA PARA PUERTAS | | 7AC/15 ENCUENTRO DOBLE PLETINA C.E. | | 7AC/17 PERNO ARRATRE PLETINAS DE 24 mm | |
| | SERIES ALL5 EPOK | | SERIES ALL5 CB40 CB45 RT45 RT65 EPOK | | SERIES ALL5 CB40 CB45 RT45 RT65 EPOK |
| 7AC/19 PERNO ARRATRE PLETINAS DE 12 mm | | 7AC/20 TERMINAL DE PLETINAS | | 7AC/21 PASADOR OCULTO 2ª HOJA | |
| | SERIES ALL5 | | SERIES ALL5 CB40 CB45 RT45 RT65 | | SERIES CB40 CB45 RT45 RT65 |
| 7AC/22 PASADORES OCULTOS 2ª HOJA OSCILOBATIENTE | | 7AC/27 ARRASTRES PARA PLETINAS | | 7AC/34 ENCUENTRO DE CIERRE MARCO | |
| | SERIES ALL5 | | SERIES ALL5 | | SERIES CB40 CB45 RT45 RT65 |
| 7AC/36 ENCUENTRO LATERAL CIERRE MARCO | | 7AC/37 ENCUENTRO CIERRE MARCO 2 HOJAS | | 7AC/49 KIT PASADORES HOJA PASIVA DE OSCILOBATIENTE C.E. | |
| | SERIES CB40 CB45 RT45 RT65 | | SERIES ALL5 CB40 CB45 RT45 RT65 | | SERIES CB40 CB45 RT45 RT65 |
| 7AC/52 ENCUENTRO LATERAL CIERRE MARCO C.E. | | 7AC/53 PIVOTE DE CIERRE REGULABLE | | 7AC/55 TERCER PUNTO DE CIERRE PARA OSCILOBATIENTE C.E. | |
| | SERIES ALL5 | | SERIES ALL5 | | SERIES ALL5 CB40 P400 |
| 7AC/60 TERCER PUNTO DE CIERRE OSCILOBATIENTE | | 7BI/01 X BISAGRA PIVOTANTE | NE | 7BI/03 X BISAGRA CON MUELLE VAIVEN (2 UNIDADES) | LB - NE |



ACCESORIOS

Los derechos de reproducción y propiedad de este catálogo pertenecen a PROVEDAL y solamente puede utilizarse o cederse con el consentimiento escrito del propietario. RESERVADOS TODOS LOS DERECHOS

| | | | | | |
|---|--|---|--|---|--|
|  | SERIES ALL5 CB40 P400 |  | SERIES ALL5 |  | SERIES ALL5 |
| 7BI/04 X BISAGRA SIMPLE CON MUELLE (2 UNIDADES) | LB - NE | 7BI/07 X BISAGRA MEKANICA | LB - NE | 7BI/10 X BISAGRA MORSA | LB - NE - ORO |
|  | SERIES ALL5 |  | SERIES CB40 CB45 RT45 |  | SERIES CB40 CB45 RT45 RT65 |
| 7BI/15 X BISAGRA HOJA SOBRE HOJA | LB - NE - ORO | 7BI/16 BISAGRA REFORZADA PARA CANAL DE CAMARA EUROPEA | LB - NE | 7BI/22 X BISAGRA EASY C.E. | LB - NE - ORO - PL |
|  | SERIES EPOK |  | SERIES EPOK |  | SERIES ALL5 |
| 7BI/26 X BISAGRA MARCO A HOJA | LB - NE | 7BI/30 X BISAGRA JIRAFa MARCO A HOJA | LB - NE | 7BI/60 X KIT OSCIOBATIENTE (2 UNIDADES) | LB - NE - ORO |
|  | SERIES DIVI |  | SERIES ALL5 |  | SERIES CB40 |
| 7BI/70 X BISAGRA DIVISION | LB - NE | 7BI/72 X BISAGRA CONTRAVENTANA | LB - NE | 7BI/73 X JUEGO BISAGRAS PIVOTANTE C.E. | LB - NE |
|  | SERIES ALL5 |  | SERIES ALL5 |  | SERIES CB40 CB45 RT45 RT65 |
| 7CO/02 COMPAS OSCIOBATIENTE HASTA 540 mm DE HOJA | | 7CO/03 COMPAS OSCIOBATIENTE HASTA 1350 mm DE HOJA | | 7CO/04 COMPAS OSCIOBATIENTE HASTA 530 mm DE HOJA C.E. | |
|  | SERIES CB40 CB45 RT45 RT65 |  | SERIES ALL5 CB40 CB45 RT45 RT65 |  | SERIES ALL5 CB40 CB45 RT45 RT65 P400 |
| 7CO/05 COMPAS OSCIOBATIENTE HASTA 1350 mm DE HOJA C.E. | | 7CO/11 COMPAS HOJA BASCULANTE | | 7CO/12 BISAGRA COMPAS | |



ACCESORIOS

| | | | | | |
|--|--|---|--|--|--|
| | SERIES ALL5 CB40 CB45 RT45 RT65 P400 | | SERIES ALL5 CB40 CB45 RT45 RT65 P400 | | SERIES SPCE |
| 7CO/50 X MANDO A DISTANCIA NEWTON | LB - NE | 7CO/51 X PERFIL TAPETA NEWTON | LB - NE | 7CR/06 X MANILLA SUPER | LB - NE |
| | SERIES CB40 CB45 RT45 RT65 | | SERIES CB40 CB45 RT45 RT65 | | SERIES CB40 CB45 RT45 RT65 |
| 7CR/07 X CREMONA PRACTICABLE LISSA | LB - NE | 7CR/08 X CREMONA OSCIOBATIENTE LISSA | LB - NE | 7CR/09 CIERRE HOJA BASCULANTE AUTO INSTALABLE | LB - NE |
| | SERIES CB40 CB45 RT45 RT65 | | SERIES EX60 CB74 TALL RQ75 | | SERIES ALL5 EPOK P400 |
| 7CR/15 CIERRE HOJA BASCULANTE AUTO INSTALABLE | LB - NE | 7CR/30 X CREMONA LARGA PARA CORREDERA | LB - NE | 7CR/31 X CREMONA APERTURA EXTERNA | LB - NE |
| | SERIES ALL5 CB40 CB45 RT45 RT65 | | SERIES SPCE | | SERIES ALL5 CB40 CB45 RT45 P400 |
| 7CR/35 X CREMONA A CUADRADILLO 7 mm | LB - NE | 7CR/82 X CREMONA PLANA A CUADRADILLO 7 mm (PROCOMSA) | LB - NE | 7CR/85 X MANUBRIO RECUPERABLE | LB - NE - PL - ORO - IN |
| | SERIES ALL5 | | SERIES ALL5 | | SERIES CB40 |
| 7CR/124 X CREMONA PRACTICABLE | LB - NE | 7CR/126 X CREMONA OSCIOBATIENTE | LB - NE | 7KT/03 KIT CIERRE VENTANA PIVOTANTE C.E. | |
| | SERIES CB40 | | SERIES CB40 | | SERIES RT45 |
| 7KT/04 KIT DE CIERRE SUPLEMENTARIO VENTANA PIVOTANTE C.E. | | 7KT/06 KIT TAPAS INVERSOR CURVO | | 7KT/07 KIT TAPAS INVERSOR CURVO | |



ACCESORIOS

Los derechos de reproducción y propiedad de este catálogo pertenecen a PROVEDAL y solamente puede utilizarse o cederse con el consentimiento escrito del propietario. RESERVADOS TODOS LOS DERECHOS

| | | | | | |
|---|--|---|--|--|--|
| | SERIES EPOK | | SERIES ALL5 | | SERIES ALL5 |
| 7KT/08 KIT TAPAS INVERSORAS | | 7KT/11 KIT TAPAS INVERSOR ALLCO 5 PUERTA | | 7KT/12 KIT TAPAS INVERSOR | |
| | SERIES EPOK | | SERIES EPOK | | SERIES CB45 RT45 |
| 7KT/16 KIT TAPAS INFERIORES PARA EPOK/16 | | 7KT/17 KIT TAPAS INFERIORES PARA EPOK/17 | | 7KT/26 KIT TAPAS INVERSOR | |
| | SERIES CB40 | | SERIES RT65 | | SERIES ALL5 |
| 7KT/27 KIT TAPAS INVERSOR | | 7KT/28 KIT TAPAS INVERSOR | | 7KT/101 X LB - NE KIT OSCIOBATIENTE COMPLETO CON CREMONA COMPAS PEQUEÑO | |
| | SERIES ALL5 | | SERIES CB40 CB45 RT45 RT65 | | SERIES CB40 CB45 RT45 RT65 |
| 7KT/102 X LB - NE KIT OSCIOBATIENTE COMPLETO CON CREMONA COMPAS GRANDE | | 7KT/104 LB - NE KIT OSCIOBATIENTE COMPLETO CON CREMONA Y COMPAS PEQUEÑO C.E. | | 7KT/105 X LB - NE KIT COMPLETO OSCIOBATIENTE CON CREMONA COMPAS GRANDE C.E. | |
| | SERIES CB40 RT45 RT65 | | SERIES CB40 RT45 RT65 | | SERIES CB40 RT45 RT65 |
| 7KT/106 LB - NE KIT OSCIOB. COMPAS PEQUEÑO C.E. REGULABLE (+ CREMONA 7CR/08) | | 7KT/107 LB - NE KIT OSCIOB. COMPAS GRANDE C.E. REGULABLE (+ CREMONA 7CR/08) | | 7KT/108 LB - NE KIT BISAGRAS 2ª HOJA OSCIOBAT. C.E. REGULABLE | |
| | SERIES ALL5 CB40 RT45 P400 | | SERIES ALL5 CB40 RT45 P400 | | SERIES ALL5 CB40 RT45 P400 |
| 7MT/60 X LB - NE - PL TIRADOR DUO DE 350 mm | | 7MT/61 X LB - NE - PL TIRADOR DUO DE 350 mm | | 7MT/62 X LB - NE - PL TIRADOR DUO INDIVIDUAL DE 350 mm DERECHO / IZQUIERDO | |



ACCESORIOS

| | | | | | |
|---|------------------------|---|------------------------|---|----------------|
|  | SERIES ALL5 SPCE |  | SERIES CB40 RT45 |  | SERIES ALL5 |
| 7PA/05 PASADOR PARA ENCASTAR | | 7PA/09 PASADOR 2ª HOJA TOTEM C.E. | | 7PA/10 GUIA PARA PASADOR TOTEM | |
|  | SERIES SPCE |  | SERIES SPCE |  | SERIES SPCE |
| 7SP/01 X BISAGRA SPCE | LB - NE | 7SP/02 X JUEGO DE BISAGRAS DESLIZADORAS | LB - NE | 7SP/09 PASADOR DOBLE ACCION | |
|  | SERIES SPCE |  | SERIES SPCE |  | SERIES SPCE |
| 7SP/16 MECANISMO DOBLE ACCION INTERNO | | 7SP/18 MECANISMO BIDIRECCIONAL | | 7SP/20 CILINDRO CIEGO (UN LADO) | |
|  | SERIES SPCE |  | SERIES SPCE |  | SERIES SPCE |
| 7SP/21 CERRADURA CON CONTRAPLACA | | 7SP/22 DEDAL PARA VARILLA DE METRICO 8 | | 7SP/30 GOMA IMANTADA DE TAPAJUNTAS | |
|  | SERIES SPCE |  | SERIES SPCE |  | SERIES SPCE |
| 7SP/31 GOMA IMANTADA DE JUNTA CENTRAL | | 7SP/32 GOMA TAPAJUNTAS REPORTE CENTRAL | | 7SP/33 DEDAL PARA VARILLA METRICO 6 | |
|  | SERIES SPCE |  | SERIES SPCE |  | SERIES ALL5 |
| 7SP/34 VARILLA ROSCADA METRICO 6 LONGITUD 1 ml | | 7SP/40 COMPENSADOR OBRA | | 7VA/01 X ESQUINERO PARA JUNQUILLO REDONDO H-11 | LB - NE |



ACCESORIOS

Los derechos de reproducción y propiedad de este catálogo pertenecen a PROVEDAL y solamente puede utilizarse o cederse con el consentimiento escrito del propietario. RESERVADOS TODOS LOS DERECHOS.

| | | | | | |
|---|--|---|--|---|--|
|  | SERIES ALL5 |  | SERIES CB40 CB45 RT45 RT65 |  | SERIES TODAS |
| 7VA/02 X ESQUINERO PARA JUNQUILLO REDONDO H-24 | LB - NE | 7VA/08 X ESQUINERO PARA JUNQUILLO REDONDO | LB - NE | 7VA/10 X CHAPA RESPIRADERO GRANDE | LB - NE - PL - BR - LC |
|  | SERIES CB40 CB45 RT45 RT65 |  | SERIES ALL5 |  | SERIES C640 EX60 CB74 RQ75 |
| 7VA/19 X GRAPA PARA JUNQUILLO REDONDO C.E. | | 7VA/42 CLIP SUJECCION PERFIL BURLETE ALL5/87 | | 8CI/01 X CIERRE "GAMMA" LLAVE SIN TORNILLOS | LB - NE |
|  | SERIES WOOS |  | SERIES C640 EX60 CB74 RQ75 |  | SERIES EX60 CB74 RQ75 |
| 8CI/04 COMPLEMENTO CIERRE 8CI/25 PARA CORREDERA WOOS | | 8CI/25 X CIERREALFA | LB - NE | 8CI/26 X CIERRE ALFA CON UÑERO | LB - NE |
|  | SERIES C640 EX60 CB74 RQ75 |  | SERIES C640 EX60 CB74 RQ75 |  | SERIES C640 EX60 CB74 RQ75 |
| 8CI/34 X CIERRE GAMMA SIN TORNILLOS | LB - NE | 8CI/35 X CIERRE GAMMINO SIN TORNILLOS | LB - NE | 8CI/36 X CIERRE DELFIN | LB - NE |
|  | SERIES C640 EX60 CB74 RQ75 |  | SERIES EX60 CB74 RQ75 |  | SERIES C640 EX60 CB74 RQ75 |
| 8CI/39 X UÑERO EXTERIOR | LB - NE | 8CI/50 X CERRADURA PARA CORREDERA | LB - NE | 8CI/59 X TIRADOR GAMMA | LB - NE |
|  | SERIES C640 EX60 CB74 RQ75 |  | SERIES SLID |  | SERIES C640 |
| 8CI/61 X TIRADOR ALFA | LB - NE | 8CI/62 TIRADOR MOSQUITERA | | 8CI/89 CONTRACIERRE ALFA | |



ACCESORIOS

| | | | | | |
|---|------------------------|---|--------------------------------|---|------------------------|
|  | SERIES EX60 CB74 |  | SERIES EX60 CB74 RQ75 |  | SERIES CB74 EX60 |
| 8CI/90 CONTRACIERRE ALFA | | 8CI/95 CONTRACIERRE PERIMETRAL ALFA | | 8KT/03 KIT DE 16 ESCUADRAS DE ALUMINIO REFUERZO HOJA CB74 | |
|  | SERIES CB74 EX60 |  | SERIES CB74 EX60 |  | SERIES VITR |
| 8KT/04 KIT DE 16 ESCUADRAS DE PLASTICO REFUERZO HOJA CB74 | | 8KT/06 KIT ESCUADRAS DE ALINEAMIENTO (16 UNIDADES) | | 8KT/10 KIT VITRINA PEQUEÑO | |
|  | SERIES VITR |  | SERIES CB74 EX60 |  | SERIES CB74 EX60 |
| 8KT/11 KIT VITRINA GRANDE | | 8KT/21 KIT DE MONTAJE CORREDERA PERIMETRAL ESC. DE ALUMINIO | | 8KT/22 KIT DE TOPES CORREDERA PERIMETRAL | |
|  | SERIES EX60 CB74 |  | SERIES CB74 EX60 |  | SERIES C640 |
| 8KT/23 TAPON REMATE HOJA REFORZADA | | 8KT/26 KIT DE MONTAJE CORREDERA PERIMETRAL ESC. PLASTICO | | 8KT/30 KIT CORTAVIENTOS CORREDERA | |
|  | SERIES CB74 EX60 |  | SERIES RQ75 |  | SERIES RQ75 |
| 8KT/36 KIT DE TAPAS TERMINALES CRUCE | | 8RQ/01 KIT DE TOPES Y CORTAVIENTOS SISTEMAS RQ | | 8RQ/03 KIT DE TAPAS DE CRUCE SISTEMAS RQ | |
|  | SERIES RQ75 |  | SERIES RQ75 |  | SERIES RQ75 |
| 8RQ/05 KIT CORTAVIENTOS TAPA CRUCE SISTEMAS RQ | | 8RQ/06 ENCUENTRO DE CIERRE A MARCO SISTEMAS RQ | | 8RQ/08 KIT DE CALCES PARA RUEDAS SISTEMAS RQ | |



ACCESORIOS

Los derechos de reproducción y propiedad de este catálogo pertenecen a PROVEDAL y solamente puede utilizarse o cederse con el consentimiento escrito del propietario. RESERVADOS TODOS LOS DERECHOS

| | |
|---|----------------|
|  | SERIES RQ75 |
| 8RQ/09 KIT TOPES DE CENTRO HOJA A HOJA SISTEMAS RQ | |





| | |
|---|------------------|
|  | SERIES FORROS |
| 8RQ/10 ESCUADRA FORRO | |

| | |
|---|----------------|
|  | SERIES RQ75 |
| 8RQ/11 KIT ESCUADRAS DE ALINEAMIENTO SISTEMAS RQ | |

| | |
|---|----------------|
|  | SERIES RQ75 |
| 8RQ/12 RODAMIENTO SIMPLE REGULABLE SISTEMAS RQ | |

| | |
|---|----------------|
|  | SERIES RQ75 |
| 8RQ/14 RODAMIENTO TANDEM REGULABLE SISTEMAS RQ | |

| | |
|---|----------------|
|  | SERIES RQ75 |
| 8RQ/16 RUEDA SIMPLE REFORZADA REGULABLE SISTEMAS RQ | |

| | |
|--|---|
|  | A  |
| | B  |
| | C  |
| | D+E  |
| MECANISMO | |

| | | | |
|--|----------------------|-----|----------------|
| A | CALCE CERRADERO | 1 | SERIES RQ75 |
| B | CERRADERO | 1 | |
| C | SEGURO ANTIELEVACION | 1 | |
| D+E | CALCE MECANISMO | 1 | |
| H | ALTURA TOTAL | 125 | |
| 8RQ/510 MECANISMO CREMONA CORREDERA DE H - 125 mm | | | |

| | | | |
|--|----------------------|-----|----------------|
| A | CALCE CERRADERO | 2 | SERIES RQ75 |
| B | CERRADERO | 2 | |
| C | SEGURO ANTIELEVACION | 1 | |
| D+E | CALCE MECANISMO | 2 | |
| H | ALTURA TOTAL | 600 | |
| 8RQ/511 MECANISMO CREMONA CORREDERA DE H - 600 mm | | | |

| | | | |
|---|----------------------|------|----------------|
| A | CALCE CERRADERO | 2 | SERIES RQ75 |
| B | CERRADERO | 2 | |
| C | SEGURO ANTIELEVACION | 1 | |
| D+E | CALCE MECANISMO | 3 | |
| H | ALTURA TOTAL | 1000 | |
| 8RQ/512 MECANISMO CREMONA CORREDERA DE H - 1000 mm | | | |

| | | | |
|---|----------------------|------|----------------|
| A | CALCE CERRADERO | 3 | SERIES RQ75 |
| B | CERRADERO | 3 | |
| C | SEGURO ANTIELEVACION | 1 | |
| D+E | CALCE MECANISMO | 5 | |
| H | ALTURA TOTAL | 1800 | |
| 8RQ/513 MECANISMO CREMONA CORREDERA DE H - 1800 mm | | | |

| | |
|---|----------------|
|  | SERIES RQ75 |
| 8RQ/16 RUEDA DOBLE REFORZADA REGULABLE SISTEMAS RQ | |

| | |
|---|----------------|
|  | SERIES C640 |
| 8RU/04 RODAMIENTO SIMPLE REFORZADO | |

| | |
|---|----------------|
|  | SERIES SLID |
| 8RU/06 RODAMIENTO MOSQUITERA PARA SLID/50 | |











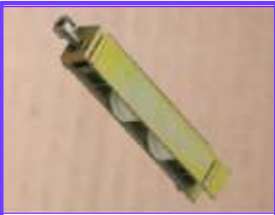

| | |
|---|------------------------|
|  | SERIES CB74 EX60 |
| 8RU/50 RODAMIENTO SIMPLE REGULABLE | |

| | |
|---|------------------------|
|  | SERIES CB74 EX60 |
| 8RU/51 RODAMIENTO TANDEM REFORZADO EXTRA AGUJAS | |

| | |
|---|------------------------|
|  | SERIES CB74 EX60 |
| 8RU/52 RODAMIENTO TANDEM REFORZADO RUEDA DE AGUJAS | |

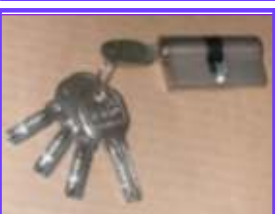
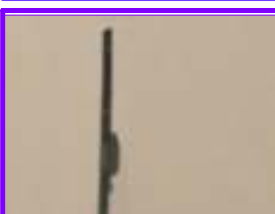
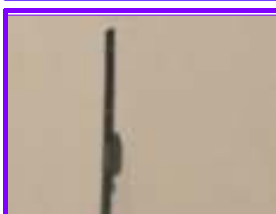

ACCESORIOS

| | | | | | |
|---|--|---|------------------------|---|--|
|  | SERIES CB74 EX60 |  | SERIES C640 |  | SERIES ALL5 EPOK |
| 8RU/53 RODAMIENTO TANDEM REGULABLE | | 8RU/104 RODAMIENTO TANDEM | | 9CE/01 CILINDRO NIQUEL MATE 30+30 | |
|  | SERIES CB40 CB45 RT45 |  | SERIES RT65 |  | SERIES CB40 CB45 RT45 RT65 ALL5 |
| 9CE/02 CILINDRO NIQUEL MATE 30+40 | | 9CE/03 CILINDRO NIQUEL MATE 30+60 | | 9CE/05 RESBALON CON CONTRAPLACA | |
|  | SERIES ALL5 EPOK |  | SERIES ALL5 EPOK |  | SERIES ALL5 CB40 CB45 RT45 RT65 EPOK |
| 9CE/06 CERRADURA PICAPORTE AGUJA DE 25 | | 9CE/07 CERRADURA RESBALON AGUJA DE 25 | | 9CE/10 KIT CONTACTOR ELECTRICO | |
|  | SERIES ALL5 EPOK |  | SERIES ALL5 EPOK |  | SERIES ALL5 EPOK |
| 9CE/16 CILLNDRO 30+30 CON LLAVE DE SEGURIDAD | | 9CE/11 CERRADURA 3 PUNTOS PICAPORTE AGUJA DE 30 | | 9CE/13 CERRADURA 3 PUNTOS RESBALON AGUJA DE 30 | |
|  | SERIES CB40 CB45 RT45 |  | SERIES ALL5 EPOK |  | SERIES ALL5 EPOK |
| 9CE/17 CILINDRO 30+40 CON LLAVE DE SEGURIDAD | | 9CE/20 CONTRAPLACA REGULABLE | | 9CE/23 CONTRAPLACA REGULABLE PARA PUNTOS ADICIONALES (3 PUNTOS) | |
|  | SERIES CB40 CB45 RT45 RT65 | | | | |
| | | | | 9CE/24 CONTRAPLACA REGULABLE C.E. | |



ACCESORIOS

Los derechos de reproducción y propiedad de este catálogo pertenecen a PROVEDAL y solamente puede utilizarse o cederse con el consentimiento escrito del propietario. RESERVADOS TODOS LOS DERECHOS

| | | | | | |
|---|--|---|--------------------------------|---|--|
|  | SERIES VITR |  | SERIES VITR |  | SERIES ALL5 CB40 CB45 RT45 RT65 |
| 9CE/40 CERRADURA VITRINA | | 9CE/41 CERRADURA VITRINA SERRETA | | 9CE/52 CERRADERO ELECTRONIC | |
|  | SERIES ALL5 CB40 CB45 RT45 RT65 |  | SERIES CB40 RT45 RT65 |  | SERIES CB40 RT45 RT65 |
| 9CE/60 ESCUDO DE CILINDRO | | 9CE/74 CERRADURA 3 PUNTOS SOBREPUESTA PICAPORTE Y ALDABA AGUJA DE 30 | | 9CE/75 CERRADURA 3 PUNTOS SOBREPUESTA PICAPORTE Y RESBALON AGUJA DE 30 | |
|  | SERIES CB40 CB45 RT45 RT65 | | | | |
| 9CE/71 CERRADURA PICAPORTE AGUJA DE 35 | | | | | |
|  | SERIES CB40 CB45 RT45 RT65 |  | SERIES EPOK |  | SERIES ALL5 EPOK |
| 9CE/72 CERRADURA RESBALON AGUJA DE 35 | | 9ES/06 ESCUADRA CAMBIO DE GRADO (24 x 11) | | 9ES/07 ESCUADRA CAMBIO DE GRADO (41 x 11) | |
|  | SERIES ALL5 |  | SERIES ALL5 EPOK EX60 |  | SERIES ALL5/28 |
| 9ES/10 SUPLEMENTO PARA PERFILES DE PUERTA (COMBINAR CON 9ES/11) | | 9ES/11 ESCUADRA DE TETONES | | 9ES/12 ESCUADRA TETONES PARA CONTRAVENTANA ALL5/28 | |
|  | SERIES SPCE |  | SERIES WOOD WOOS |  | SERIES CB74 EX60 EPOK |
| 9ES/14 ESCUADRA TETONES INTERNOS (24 x 11) | | 9ES/15 ESCUADRA TETONES (24 x 16) | | 9ES/16 ESCUADRA TETONES (24 x 11) | |



ACCESORIOS

| | | | | | |
|--|--|---|------------------------|---|--------------------------------|
| | SERIES ALL5 EPOK EX60 | | SERIES P400 | | SERIES P400 |
| 9ES/18 ESCUADRA ENCASTAR (41 x 11) | | 9ES/20 ESCUADRA ENCASTAR (36 x 14) | | 9ES/21 ESCUADRA ENCASTAR (36 x 31) | |
| | SERIES WOOD CB40 CB45 RT45 | | SERIES CB40 | | SERIES RT65 |
| 9ES/27 ESCUADRA CAMBIO DE GRADO (24 x 14) | | 9ES/29 ESCUADRA DE ALINEACION INTERNA 16 UNIDADES | | 9ES/33 ESCUADRA INTERIOR COBRA RT65 | |
| | SERIES RT65 | | SERIES RT65 | | SERIES RT65 |
| 9ES/34 ESCUADRA EXTERIOR COBRA RT65 | | 9ES/35 ESCUADRA DE ALINEACION COBRA RT65 16 UNIDADES | | 9ES/36 ESCUADRA EXTERIOR COBRA RT65 (PUERTA) | |
| | SERIES RT65 | | SERIES EPOK | | SERIES CB40 CB45 RT45 |
| 9ES/37 ESCUADRA INTERIOR COBRA RT65 (PUERTA) | | 9ES/42 ESCUADRA TETON INTERNO PARA EPOK/17 | | 9ES/43 ESCUADRA TETONES (24 x 14) | |
| | SERIES CB40 RT45 | | SERIES CB40 RT45 | | SERIES CB40 CB45 RT45 |
| 9ES/44 ESCUADRA TETONES MARCO PUERTA (24 x 26) | | 9ES/45 ESCUADRA TETONES HOJA PUERTA (24 x 38) | | 9ES/46 ESCUADRA ESPANSION (24 x 14) | |
| | SERIES CB40 RT45 | | SERIES CB40 RT45 | | SERIES RQ75 |
| 9ES/47 ESCUADRA ESPANSION MARCO PUERTA (24 x 26) | | 9ES/48 ESCUADRA ESPANSION HOJA PUERTA (24 x 38) | | 9ES/49 ESCUADRA TETONES (17 x 11) | |









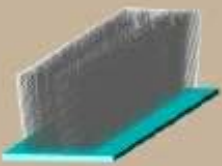
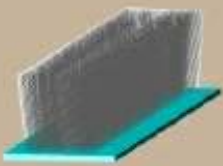
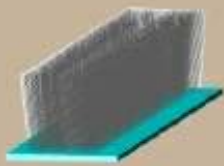
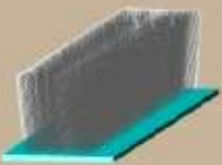
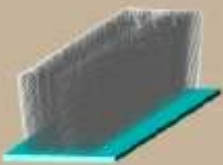
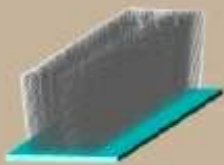
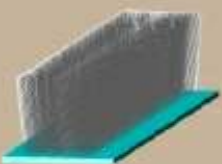
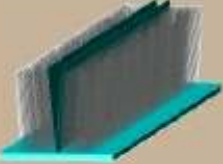
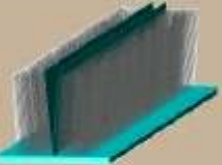

ACCESORIOS

| | | | | | |
|--|--------------------------------|--|--|---|--|
| | SERIES REG/04 | | SERIES FORR | | SERIES FORR |
| 9ES/51 ESCUADRA FIJACION REG/04 16 UNIDADES | | 9ES/56 ESCUADRA ALINEAMIENTO FORRO | | 9ES/57 ESCUADRA FIJACION FORRO | |
| | SERIES CB40 CB45 RT45 | | SERIES CB40 CB45 RT45 | | SERIES SLID/50 |
| 9ES/59 ESCUADRA ALINEACION EXTERIOR HOJA (16 unid.) | | 9ES/60 ESCUADRA ALINEACION INTERIOR HOJA (16 unid.) | | 9ES/70 ESCUADRA MOSQUITERA | |
| | SERIES DIVI | | SERIES DIVI | | SERIES DIVI |
| 9ES/76 UNION DIVISION PEQUEÑA | | 9ES/77 ESCUADRA MARCOS DIVISION | | 9ES/78 GRAPA SUJECCION TABLEROS | |
| | SERIES DIVI | | SERIES P400 | | SERIES P400 |
| 9ES/79 UNION DIVISION GRANDE | | 9ES/80 UNION PEQUEÑA P400 | | 9ES/81 UNION GRANDE P400 | |
| | SERIES ALL5 | | SERIES CB40 CB45 RT45 RT65 | | SERIES CB40 CB45 RT45 RT65 |
| 9ES/85 UNION ALLCO 5 | | 9ES/88 UNION PEQUEÑA C.E. | | 9ES/89 UNION GRANDE C.E. | |
| | SERIES EPOK | | SERIES | | SERIES C640 |
| 9ES/101 ESCUADRA ANGULO INTERNO | | 9FE/02 FELPA 5 x 7 | | 9FE/03 FELPA 7 x 5 | |



ACCESORIOS

| | | | | | |
|---|-----------------|---|-----------------|---|------------------------|
|  | SERIES EX60 |  | SERIES RQ75 |  | SERIES |
| 9FE/04 FELPA 7 x 6 | | 9FE/06 FELPA 7 x 9 | | 9FE/15 FELP 4,5 x 6 | |
|  | SERIES P400 |  | SERIES |  | SERIES |
| 9FE/09 FELPA 14 x 12 | | 9FE/11 FELPA 5 x 10 | | 9FE/12 FELPA 5 x 15 | |
|  | SERIES |  | SERIES EX60 |  | SERIES RQ75 WOOS |
| 9FE/15 FELP 4,5 x 6 | | 9FE/21 FELPA 7 x 6 FIN SEAL | | 9FE/22 FELPA 7 x 7,5 FIN SEAL | |
|  | SERIES |  | SERIES TODAS |  | SERIES TODAS |
| 9FE/26 FELPA 7 x 17 FIN SEAL | | 9GO/01 GOMA DE CUÑA PARA HUECO DE 4 mm | | 9GO/02 GOMA DE CUÑA PARA HUECO DE 5 mm | |
|  | SERIES TODAS |  | SERIES TODAS |  | SERIES TODAS |
| 9GO/03 GOMA DE CUÑA PARA HUECO DE 6 mm | | 9GO/04 GOMA DE CUÑA PARA HUECO DE 3 mm | | 9GO/05 GOMA DE CUÑA PARA HUECOS DE 5 - 6 mm | |
|  | SERIES TODAS |  | SERIES TODAS |  | SERIES TODAS |
| 9GO/06 GOMA DE CUÑA PARA HUECO DE 2 mm | | 9GO/07 GOMA DE CUÑA PARA HUECO DE 7 mm | | 9GO/08 GOMA DE CUÑA PARA HUECO DE 8 mm | |



ACCESORIOS

| | | | | | |
|---|--------------------------------|---|--|---|----------------|
|  | SERIES TODAS |  | SERIES EPOK CB40 CB45 RT45 RT65 SPCE |  | SERIES ALL5 |
| 9GO/09 GOMA DE CUÑA PARA HUECO DE 9 mm | | 9GO/10 GOMA ESPUMA JUNTA DE HOJA A MARCO | | 9GO/11 GOMA DE JUNTA CENTRAL (EPDM) | |
|  | SERIES RQ75 |  | SERIES RQ75 |  | SERIES RQ75 |
| 9GO/16 PVC AISLANTE MARCO SISTEMAS RQ | | 9GO/17 PVC AISLANTE CRUCE SISTEMAS RQ | | 9GO/18 GOMA CUBREGUIAS SISTEMAS RQ | |
|  | SERIES DIVI |  | SERIES DIVI |  | SERIES DIVI |
| 9GO/20 GOMA DE DIVISION PARA CRISTAL DE 4 mm | | 9GO/21 GOMA DE DIVISION PARA CRISTAL DE 4 mm (COMPLEMENTO DE 9GO/22) | | 9GO/22 GOMA DE DIVISION PARA CRISTAL DE 4 mm (COMPLEMENTO DE 9GO/21) | |
|  | SERIES ALL5 |  | SERIES ALL5 |  | SERIES ALL5 |
| 9GO/51 GOMA DE JUNTA PARA ALLCO 5 PUERTA | | 9GO/52 GOMA JUNTA DE HOJA A MARCO | | 9GO/53 GOMA DE TOPE PARA JUNTA | |
|  | SERIES ALL5 |  | SERIES ALL5 |  | SERIES ALL5 |
| 9GO/54 GOMA DE JUNTA CENTRAL | | 9GO/59 GOMA DE CUÑA EXTERIOR GUIADA | | 9GO/61 ESQUINERO GOMA JUNTA CENTRAL | |
|  | SERIES CB45 RT45 RT65 |  | SERIES CB40 |  | SERIES REG |
| 9GO/63 ESQUINERO GOMA JUNTA CENTRAL | | 9GO/66 ESQUINERO GOMA JUNTA CENTRAL | | 9GO/74 GOMA TOPE REGISTRO (REG/04) | |















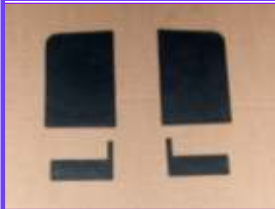
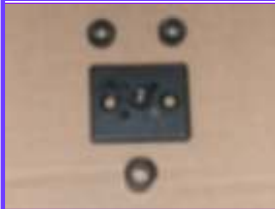



ACCESORIOS

| | | | | | |
|--|--|---|--------------------------------|---|--------------------------------|
| | SERIES SLID | | SERIES C640 | | SERIES EPOK SPCE TRIS |
| 9GO/77 GOMA PARA MOSQUITERA (SLID/49) | | 9GO/85 JUNTA DE UNION A FIJO | | 9GO/90 GOMA JUNTA DE LAMA MALLORQUINA | |
| | SERIES CB40 CB45 RT45 RT65 | | SERIES CB45 RT45 RT65 | | SERIES CB40 |
| 9GO/92 GOMA JUNTA DE HOJA | | 9GO/93 GOMA DE JUNTA CENTRAL | | 9GO/94 GOMA DE JUNTA CENTRAL | |
| | SERIES CB40 CB45 RT45 RT65 | | SERIES 9PR | | SERIES 9PR |
| 9GO/192 GOMA JUNTA DE HOJA (ESPUMA) | | 9PR/01 PREMARCO SIN ANODIZAR DE 36 mm | | 9PR/02 ESCUADRA PREMARCO DE 36 mm | |
| | SERIES 9PR | | SERIES 9PR | | SERIES 9PR |
| 9PR/03 GARRAS AUTOCLIPABLES | | 9PR/04 CRUCETA DE 300 mm | | 9PR/05 CRUCETA DE 600 mm | |
| | SERIES 9PR | | SERIES 9PR | | SERIES 9PR |
| 9PR/06 JUEGO DE SOPORTE "F" REFORZADO BALCONERA | | 9PR/07 PERFIL PARA PASACINTAS | | 9PR/08 CAJETIN CINTA PERSIANA | |
| | SERIES 9PR | | SERIES 9PR | | SERIES 9PR |
| 9PR/09 TORNILLO DIN 7984 6 X 12 ZINCADO | | 9PR/10 JUEGO DE SOPORTE "F" SIMPLE | | 9PR/11 ESCUADRA TRAVESAÑO | |





















ACCESORIOS

Los derechos de reproducción y propiedad de este catálogo pertenecen a PROVEDAL y solamente puede utilizarse o cederse con el consentimiento escrito del propietario. RESERVADOS TODOS LOS DERECHOS

| | | | | | |
|---|--|---|------------------------|---|-----------------|
|  | SERIES 9PR |  | SERIES 9PR |  | SERIES TRIS |
| 9PR/15 PREMARCO SIN ANODIZAR DE 51 mm | | 9PR/16 ESCUADRA PREMARCO DE 51 mm | | 9TR/02 EQUIPO DE RUEDAS TRIS | |
|  | SERIES TRIS |  | SERIES TRIS |  | SERIES TODAS |
| 9TR/03 TERMINALES GUIAS TRIS | | 9TR/04 DESILZADOR INFERIOR TRIS | | 9VA/10 X LB - BR RETOCADOR LACA SPRAY (OTROS COLORES BAJO DEMANDA) | |
|  | SERIES TODAS |  | SERIES TODAS |  | SERIES TODAS |
| 9VA/11 X LB - NE - BR RETOCADOR LACA PINCEL (OTROS COLORES BAJO DEMANDA) | | 9VA/17 BOBINA FILM PROTECTOR (PARA EMBALAR) | | 9VA/20 LIMPIADOR PARA LACAS | |
|  | SERIES DIVI |  | SERIES WOOD WOOS |  | SERIES ALL5 |
| 9VA/34 TORNILLO UNION DIVISION | | 9VA/39 TORNILLO 5 X 35 | | 9VA/50 LB - NE TAPON PASO TORNILLO ZOCALO | |
|  | SERIES ALL5 CB40 CB45 RT45 RT65 WOOD |  | SERIES EPOK |  | SERIES EPOK |
| 9VA/52 X LB - NE TAPA DE DESAGUE | | 9VA/57 RETENEDOR REGULABLE DE HOJAS A MURO (GRILLO) | | 9VA/60 JUEGO DE SOPORTES LAMA OVALINA FIJA | |
|  | SERIES EPOK |  | SERIES EPOK |  | SERIES MIXT |
| 9VA/62 SOPORTES LAMA OVALINA FIJA | | 9VA/63 SOPORTES LAMA EPOK FIJA | | 9VA/91 GRAPA JUNQUILLO MIXT/05 | |



ACCESORIOS

| | | | | | |
|---|------------------------|---|-----------------|---|----------------|
|  | SERIES REG |  | SERIES TODAS |  | SERIES WOOD |
| 9VA/92 GRAPA PLANA PARA REG/01 Y REG/03 | | 9MA/74 TIJERAS PARA CORTE DE GOMA A GRADOS CON HOJA RECAMBIABLE | | 9W/103 ESCUADRA HOJA PUERTA | |
|  | SERIES WOOD |  | SERIES WOOD |  | SERIES WOOD |
| 9W/161 BLOQUE SOPORTE BISAGRA INFERIOR | | 9W/162 BIELA DE UNION ALUMINIO MADERA GRANDE | | 9W/176 BIELA UNION ALUMINIO MADERA PEQUEÑA | |
|  | SERIES WOOD |  | SERIES TODAS |  | SERIES WOOD |
| 9W/163 KIT TAPAS INVERSOR 2ª HOJA | | 9W/164 BLOQUE REGULABLE COMPENSADOR OBRA | | 9W/168 LLAVE DE GIRO PARA BIELAS DE UNION | |
|  | SERIES WOOD |  | SERIES WOOD |  | SERIES WOOD |
| 9W/173 X CREMONA DIRIGENT | NE - PL | | | | |
|  | SERIES WOOD |  | SERIES WOOD |  | SERIES WOOD |
| 9W/175 PLANTILLA BISAGRAS | | | | | |
|  | SERIES WOOD WOOS |  | SERIES WOOD |  | SERIES WOOD |
| 9W/179 CREMONA MARTELLINA | ORO - PL | | | | |
| | | 9W/190 CERRADURA SEGURIDAD R4 3 PUNTOS CON CILINDRO ALT. 1735 - 2285 | | | |
| | | 9W/191 CERRADURA SEGURIDAD SR2 3 PUNT. CON CILINDRO ALT. 1735 - 2285 | | | |

Los derechos de reproducción y propiedad de este catálogo pertenecen a PROVEDAL y solamente puede utilizarse o cederse con el consentimiento escrito del propietario. RESERVADOS TODOS LOS DERECHOS



ACCESORIOS

Los derechos de reproducción y propiedad de este catálogo pertenecen a PROVEDAL y solamente puede utilizarse o cederse con el consentimiento escrito del propietario. RESERVADOS TODOS LOS DERECHOS

| | | | | | |
|---|------------------------|---|------------------------|--|----------------|
|  | SERIES WOOD |  | SERIES WOOD |  | SERIES WOOD |
| 9W/194 CILINDRO DE 50- 50 | | 9W/195 PLACA CERRADERO PARA PUNTOS SUPLEMENTARIOS DE 3 PUNTOS | | 9W/196 "L" o "R" PLACA CERRADERO PORTERO ELEC. TIENE MANO L = IZQ. R = DER. | |
|  | SERIES WOOD |  | SERIES WOOD |  | SERIES WOOD |
| 9W/198 CILINDRO SEGURIDAD DE 50 - 50 | | 9W/200 GOMA DE JUNTA CENTRAL EPDM | | 9W/201 GOMA SEPARADORA DE MARCO A MADERA EPDM | |
|  | SERIES WOOD |  | SERIES WOOD WOOS |  | SERIES WOOD |
| 9W/202 GOMA CUBREJUNTAS DE INVERSOR EPDM | | 9W/203 GOMA AISLAMIENTO DE MARCO A MUR EPDM | | 9W/204 GOMA DE JUNTA BATIENTE INTERNA | |
|  | SERIES WOOD |  | SERIES WOOD |  | SERIES WOOD |
| 9W/205 GOMA CUÑA VIDRIO EXTERNA EPDM | | 9W/206 GOMA CUÑA VIDRIO INTERNA EPDM | | 9W/208 JUNTA INFERIOR ZOCALO PUERTA | |
|  | SERIES WOOD |  | SERIES WOOD |  | SERIES WOOD |
| 9W/209 GOMA AISLAMIENTO JUNQUILLOS DE FIJO EPDM | | 9W/211 GOMA UNION LAMAS DE PUERTA | | 9W/216 GOMA CUBREJUNTAS DE INVERSOR (PERFIL NUEVO) EPDM | |
|  | SERIES WOOD WOOS |  | SERIES WOOD WOOS |  | SERIES WOOD |
| 9W/400 X ORO - PL CANULA DECORATIVA REGISTRO | | 9W/401 GRAPA DE FIJACION ESQUINAS 12 mm | | 9W/402 GRAPA DE FIJACION ESQUINAS 15 mm | |



ACCESORIOS

| | | | | | | |
|---|------------------------------------|---|---|---|--|--|
| | SERIES WOOS | | SERIES WOOS | | SERIES WOOS | |
| 9W/500 GOMA AISLAMIENTO MARCO DE CORREDERA S MADERA EPDM | | 9W/501 GOMA DE AISLAMIENTO CRUCE DE CORREDERA EPDM | | 9W/502 GOMA DE AISLAMIENTO DE HOJA A MADERA CORREDERA EPDM | | |
| | SERIES WOOS | | SERIES WOOS | | SERIES WOOS | |
| 9W/503 GOMA CUÑA VIDRIO INTERNA CORREDERA EPDM | | 9W/504 GOMA CUÑA EXTERNA VIDRIO CORREDERA EPDM | | 9W/505 CUBREGUIAS DE CORREDERA | | |
| | SERIES WOOS | | SERIES WOOS | | SERIES WOOS | |
| 9W/506 GOMA ENCASTAR CENTRAL DE CUATRO HOJAS EPDM | | 9W/550 ESCUADRA DE HOJA CORREDERA | | 9W/551 CENTRADOR DE HOJA CORREDERA | | |
| | SERIES WOOS | | SERIES WOOS | | SERIES WOOS | |
| 9W/556 ESCUADRA DE ALINEACION MARCO CORREDERA | | 9W/559 KIT DE 4 RODAMIENTOS TANDEM REGULABLES | | 9W/570 JUEGO DE CORTAVIENTOS Y TOPES | | |
| MECANISMO | A | A CALCE CERRADERO 1 | SERIES WOOS TALL EX60 CB74 | A CALCE CERRADERO 2 | SERIES WOOS TALL EX60 CB74 | |
| | B | B CERRADERO 1 | | B CERRADERO 2 | | |
| | C | C SEGURO ANTIELEVACION 1 | | C SEGURO ANTIELEVACION 1 | | |
| | D | D CALCE MECANISMO 1 | | D CALCE MECANISMO 2 | | |
| | H ALTURA TOTAL 125 | 9W/510 MECANISMO CREMONA CORREDERA DE H - 125 mm | | H ALTURA TOTAL 600 | 9W/511 MECANISMO CREMONA CORREDERA DE H - 600 mm | |
| | A CALCE CERRADERO 2 | SERIES WOOS TALL EX60 CB74 | A CALCE CERRADERO 3 | SERIES WOOS TALL EX60 CB74 | | |
| | B CERRADERO 2 | | B CERRADERO 3 | | | |
| | C SEGURO ANTIELEVACION 1 | | C SEGURO ANTIELEVACION 1 | | | |
| | D CALCE MECANISMO 3 | | D CALCE MECANISMO 5 | | | |
| | H ALTURA TOTAL 1000 | 9W/512 MECANISMO CREMONA CORREDERA DE H - 1000 mm | | H ALTURA TOTAL 1800 | 9W/513 MECANISMO CREMONA CORREDERA DE H - 1800 mm | |



ACCESORIOS

Los derechos de reproducción y propiedad de este catálogo pertenecen a PROVEDAL y solamente puede utilizarse o cederse con el consentimiento escrito del propietario. RESERVADOS TODOS LOS DERECHOS

| | |
|---|----------------|
|  | SERIES WOOS |
| 9W/571 ESCUADRA DE ALINEAMIENTO DE HOJA CORREDERA | |

| | |
|---|----------------|
|  | SERIES WOOS |
| 9W/572 CORTAVIENTOS DE ALUMINIO | |

| | |
|---|----------------|
|  | SERIES WOOD |
| 9W/600 ENCUENTRO DE CIERRE LATERAL | |

| | |
|---|----------------|
|  | SERIES WOOD |
| 9W/601 ENCUENTRO DE CIERRE DOBLE HOJA | |

| | |
|---|----------------|
|  | SERIES WOOD |
| 9W/602 ENCUENTRO DE CIERRE BAJO OSCILOBATIENTE | |

| | |
|---|----------------|
|  | SERIES WOOD |
| 9W/603 CLIC RETENEDOR DE HOJA | |



| | | |
|---|-----------|----------------|
| ALTURA HOJA | 480 A 590 | SERIES WOOD |
| PLETINA | 270 | |
| BULONES DE CIERRE | ----- | |
| 9W/610 MECANISMO DE COTA VARIABLE DE 480 A 590 | | |

| | | |
|---|-----------|----------------|
| ALTURA HOJA | 591 A 700 | SERIES WOOD |
| PLETINA | 380 | |
| BULONES DE CIERRE | ----- | |
| 9W/611 MECANISMO DE COTA VARIABLE DE 591 A 700 | | |

| | | |
|--|------------|----------------|
| ALTURA HOJA | 701 A 1200 | SERIES WOOD |
| PLETINA | 890 | |
| BULONES DE CIERRE | ----- | |
| 9W/612 MECANISMO DE COTA VARIABLE DE 701 A 1200 | | |

| | | |
|--|------------|----------------|
| ALTURA HOJA | 951 A 1450 | SERIES WOOD |
| PLETINA | 1130 | |
| BULONES DE CIERRE | 1 | |
| 9W/613 MECANISMO DE COTA VARIABLE DE 951 A 1450 | | |

| | | |
|---|-------------|----------------|
| ALTURA HOJA | 1201 A 1700 | SERIES WOOD |
| PLETINA | 1380 | |
| BULONES DE CIERRE | 1 | |
| 9W/614 MECANISMO DE COTA VARIABLE DE 1201 A 1700 | | |

| | | |
|---|-------------|----------------|
| ALTURA HOJA | 1451 A 1950 | SERIES WOOD |
| PLETINA | 1630 | |
| BULONES DE CIERRE | 1 | |
| 9W/615 MECANISMO DE COTA VARIABLE DE 1451 A 1950 | | |

| | | |
|---|-------------|----------------|
| ALTURA HOJA | 1951 A 2450 | SERIES WOOD |
| PLETINA | 2130 | |
| BULONES DE CIERRE | 2 | |
| 9W/616 MECANISMO DE COTA VARIABLE DE 1951 A 2450 | | |

| | |
|---|----------------|
|  | SERIES WOOD |
| 9W/604 SEGURO DE FALSA MANIOBRA | |



ACCESORIOS



| | | |
|-------------------|-----------|-------------|
| ANCHURA HOJA | 280 A 400 | SERIES WOOD |
| PLETINA | ----- | |
| BULONES DE CIERRE | ----- | |

9W/621 + 9W/637
KIT COMPAS OSCIOBATIENTE ANCHO HOJA DE 280 A 400 (TIENE MANO)

| | | |
|-------------------|-----------|-------------|
| ANCHURA HOJA | 401 A 500 | SERIES WOOD |
| PLETINA | 350 | |
| BULONES DE CIERRE | ----- | |

9W/621
KIT COMPAS OSCIOBATIENTE ANCHO HOJA DE 401 A 500 (TIENE MANO)

| | | |
|-------------------|-----------|-------------|
| ANCHURA HOJA | 501 A 750 | SERIES WOOD |
| PLETINA | 590 | |
| BULONES DE CIERRE | ----- | |

9W/622
KIT COMPAS OSCIOBATIENTE ANCHO HOJA DE 501 A 750 (TIENE MANO)

| | | |
|-------------------|-----------|-------------|
| ANCHURA HOJA | 751 A 950 | SERIES WOOD |
| PLETINA | 840 | |
| BULONES DE CIERRE | 1 | |

9W/623
KIT COMPAS OSCIOBATIENTE ANCHO HOJA DE 751 A 950 (TIENE MANO)

| | | |
|-------------------|------------|-------------|
| ANCHURA HOJA | 951 A 1200 | SERIES WOOD |
| PLETINA | 1040 | |
| BULONES DE CIERRE | 1 | |

9W/624
KIT COMPAS OSCIOBATIENTE ANCHO HOJA DE 951 A 1200 (TIENE MANO)



9W/631
TERMINAL DE CIERRE INFERIOR



9W/605
FALSA BISAGRA OCULTA



9W/625
COMPAS COMPLEMENTARIO OSCIOBATIENTE



9W/630
TERMINAL DE CIERRE SUPERIOR



9W/632
TERMINAL CIERRE SUPERIOR 2 HOJAS PRACTICABLE



9W/633
TERMINAL CIERRE INFERIOR 2 HOJAS PRACTICABLE



9W/634
ESCUADRA REENVIO OSCIOBATIENTE



9W/635
PASADOR INFERIOR 2ª HOJA



9W/636
PASADOR SUPERIOR 2ª HOJA



9W/637
ESCUADRA REENVIO OSCIOBATIENTE PEQUEÑA

Los derechos de reproducción y propiedad de este catálogo pertenecen a PROVEDAL y solamente puede utilizarse o cederse con el consentimiento escrito del propietario. RESERVADOS TODOS LOS DERECHOS



ACCESORIOS

Los derechos de reproducción y propiedad de este catálogo pertenecen a PROVEDAL y solamente puede utilizarse o cederse con el consentimiento escrito del propietario. RESERVADOS TODOS LOS DERECHOS

| | | | | | |
|--|----------------|---|----------------|--|----------------|
| | SERIES WOOD | | SERIES WOOD | | SERIES WOOD |
| 9W/638 MECANISMO REENVÍO LATERAL DE 1601 A 1850 mm | | 9W/640 BISAGRA SUPERIOR REGULABLE | | 9W/641 BASE EN MARCO DE BISAGRAS | |
| | SERIES WOOD | | SERIES WOOD | | SERIES WOOD |
| 9W/642 BISAGRA INTERMEDIA PALA HOJA | | 9W/643 BASE EN MARCO DE BISAGRA INFERIOR | | 9W/644 BISAGRA INFERIOR REGULABLE DERECHA (PALA HOJA) | |
| | SERIES WOOD | | SERIES WOOD | | SERIES WOOD |
| 9W/645 BISAGRA INFERIOR REGULABLE IZQUIERDA (PALA HOJA) | | 9W/650 X ORO - PLATA CUBRE BASE DE BISAGRAS (9W/641) | | 9W/651 X ORO - PLATA CUBRE NUDO DE BISAGRAS (9W/640, 9W/642 Y COMPASES) | |
| | SERIES WOOD | | SERIES WOOD | | SERIES WOOD |
| 9W/652 X ORO - PLATA CUBRE BASE DE BISAGRAS (9W/643) | | 9W/653 X ORO - PLATA CUBRE NUDO DE BISAGRA INFERIOR IZQUIERDA (9W/645) | | 9W/654 X ORO PLATA CUBRE NUDO DE BISAGRA INFERIOR DERECHA (9W/644) | |
| | SERIES WOOD | | SERIES WOOD | | SERIES WOOD |
| 9W/660 MECANISMO VENTANA ABATIBLE ANCHO HOJA DE 701 A 1100 mm | | 9W/661 MECANISMO VENTANA ABATIBLE ANCHO HOJA 1101 A 1500 mm | | 9W/662 COMPAS PARA ABATIBLES | |
| | SERIES | | SERIES | | SERIES |
| | | | | | |



ACCESORIOS

| | | |
|--|-----------|--|
| | 9WAD0101X | KIT OSCILOPARALELA DERECHA L - 640 / 850 H - 700 / 850 |
| | 9WAD0102X | KIT OSCILOPARALELA DERECHA L - 640 / 850 H - 851 / 1100 |
| | 9WAD0103X | KIT OSCILOPARALELA DERECHA L - 640 / 850 H - 1101 / 1350 |
| | 9WAD0104X | KIT OSCILOPARALELA DERECHA L - 640 / 850 H - 1351 / 1600 |
| | 9WAD0105X | KIT OSCILOPARALELA DERECHA L - 640 / 850 H - 1601 / 1850 |
| | 9WAD0106X | KIT OSCILOPARALELA DERECHA L - 640 / 850 H - 1851 / 2100 |
| | 9WAD0107X | KIT OSCILOPARALELA DERECHA L - 640 / 850 H - 2101 / 2350 |
| | 9WAD0201X | KIT OSCILOPARALELA DERECHA L - 851 / 1100 H - 700 / 850 |
| | 9WAD0202X | KIT OSCILOPARALELA DERECHA L - 851 / 1100 H - 851 / 1100 |
| | 9WAD0203X | KIT OSCILOPARALELA DERECHA L - 851 / 1100 H - 1101 / 1350 |
| | 9WAD0204X | KIT OSCILOPARALELA DERECHA L - 851 / 1100 H - 1351 / 1600 |
| | 9WAD0205X | KIT OSCILOPARALELA DERECHA L - 851 / 1100 H - 1601 / 1850 |
| | 9WAD0206X | KIT OSCILOPARALELA DERECHA L - 851 / 1100 H - 1851 / 2100 |
| | 9WAD0207X | KIT OSCILOPARALELA DERECHA L - 851 / 1100 H - 2101 / 2350 |
| | 9WAD0301X | KIT OSCILOPARALELA DERECHA L - 1101 / 1350 H - 700 / 850 |
| | 9WAD0302X | KIT OSCILOPARALELA DERECHA L - 1101 / 1350 H - 851 / 1100 |
| | 9WAD0303X | KIT OSCILOPARALELA DERECHA L - 1101 / 1350 H - 1101 / 1350 |
| | 9WAD0304X | KIT OSCILOPARALELA DERECHA L - 1101 / 1350 H - 1351 / 1600 |
| | 9WAD0305X | KIT OSCILOPARALELA DERECHA L - 1101 / 1350 H - 1601 / 1850 |
| | 9WAD0306X | KIT OSCILOPARALELA DERECHA L - 1101 / 1350 H - 1851 / 2100 |
| | 9WAD0307X | KIT OSCILOPARALELA DERECHA L - 1101 / 1350 H - 2101 / 2350 |
| | 9WAD0401X | KIT OSCILOPARALELA DERECHA L - 1351 / 1600 H - 700 / 850 |
| | 9WAD0402X | KIT OSCILOPARALELA DERECHA L - 1351 / 1600 H - 851 / 1100 |
| | 9WAD0403X | KIT OSCILOPARALELA DERECHA L - 1351 / 1600 H - 1101 / 1350 |
| | 9WAD0404X | KIT OSCILOPARALELA DERECHA L - 1351 / 1600 H - 1351 / 1600 |
| | 9WAD0405X | KIT OSCILOPARALELA DERECHA L - 1351 / 1600 H - 1601 / 1850 |
| | 9WAD0406X | KIT OSCILOPARALELA DERECHA L - 1351 / 1600 H - 1851 / 2100 |
| | 9WAD0407X | KIT OSCILOPARALELA DERECHA L - 1351 / 1600 H - 2101 / 2350 |



ACCESORIOS

Los derechos de reproducción y propiedad de este catálogo pertenecen a PROVEDAL y solamente puede utilizarse o cederse con el consentimiento escrito del propietario. RESERVADOS TODOS LOS DERECHOS.

| | | |
|--|-----------|--|
| | 9WAI0101X | KIT OSCILOPARALELA IZQUIERDA L - 640 / 850 H - 700 / 850 |
| | 9WAI0102X | KIT OSCILOPARALELA IZQUIERDA L - 640 / 850 H - 851 / 1100 |
| | 9WAI0103X | KIT OSCILOPARALELA IZQUIERDA L - 640 / 850 H - 1101 / 1350 |
| | 9WAI0104X | KIT OSCILOPARALELA IZQUIERDA L - 640 / 850 H - 1351 / 1600 |
| | 9WAI0105X | KIT OSCILOPARALELA IZQUIERDA L - 640 / 850 H - 1601 / 1850 |
| | 9WAI0106X | KIT OSCILOPARALELA IZQUIERDA L - 640 / 850 H - 1851 / 2100 |
| | 9WAI0107X | KIT OSCILOPARALELA IZQUIERDA L - 640 / 850 H - 2101 / 2350 |

| | | |
|--|-----------|---|
| | 9WAI0201X | KIT OSCILOPARALELA IZQUIERDA L - 851 / 1100 H - 700 / 850 |
| | 9WAI0202X | KIT OSCILOPARALELA IZQUIERDA L - 851 / 1100 H - 851 / 1100 |
| | 9WAI0203X | KIT OSCILOPARALELA IZQUIERDA L - 851 / 1100 H - 1101 / 1350 |
| | 9WAI0204X | KIT OSCILOPARALELA IZQUIERDA L - 851 / 1100 H - 1351 / 1600 |
| | 9WAI0205X | KIT OSCILOPARALELA IZQUIERDA L - 851 / 1100 H - 1601 / 1850 |
| | 9WAI0206X | KIT OSCILOPARALELA IZQUIERDA L - 851 / 1100 H - 1851 / 2100 |
| | 9WAI0207X | KIT OSCILOPARALELA IZQUIERDA L - 851 / 1100 H - 2101 / 2350 |

| | | |
|--|-----------|--|
| | 9WAI0301X | KIT OSCILOPARALELA IZQUIERDA L - 1101 / 1350 H - 700 / 850 |
| | 9WAI0302X | KIT OSCILOPARALELA IZQUIERDA L - 1101 / 1350 H - 851 / 1100 |
| | 9WAI0303X | KIT OSCILOPARALELA IZQUIERDA L - 1101 / 1350 H - 1101 / 1350 |
| | 9WAI0304X | KIT OSCILOPARALELA IZQUIERDA L - 1101 / 1350 H - 1351 / 1600 |
| | 9WAI0305X | KIT OSCILOPARALELA IZQUIERDA L - 1101 / 1350 H - 1601 / 1850 |
| | 9WAI0306X | KIT OSCILOPARALELA IZQUIERDA L - 1101 / 1350 H - 1851 / 2100 |
| | 9WAI0307X | KIT OSCILOPARALELA IZQUIERDA L - 1101 / 1350 H - 2101 / 2350 |

| | | |
|--|-----------|--|
| | 9WAI0401X | KIT OSCILOPARALELA IZQUIERDA L - 1351 / 1600 H - 700 / 850 |
| | 9WAI0402X | KIT OSCILOPARALELA IZQUIERDA L - 1351 / 1600 H - 851 / 1100 |
| | 9WAI0403X | KIT OSCILOPARALELA IZQUIERDA L - 1351 / 1600 H - 1101 / 1350 |
| | 9WAI0404X | KIT OSCILOPARALELA IZQUIERDA L - 1351 / 1600 H - 1351 / 1600 |
| | 9WAI0405X | KIT OSCILOPARALELA IZQUIERDA L - 1351 / 1600 H - 1601 / 1850 |
| | 9WAI0406X | KIT OSCILOPARALELA IZQUIERDA L - 1351 / 1600 H - 1851 / 2100 |
| | 9WAI0407X | KIT OSCILOPARALELA IZQUIERDA L - 1351 / 1600 H - 2101 / 2350 |



ACCESORIOS

Accesorios lama Perla 36 mm

| | Número de lamas | Código mecanismo simple | Código mecanismo reforzado | Medida mínima | Medida máxima |
|----------------------|--------------------|----------------------------|-------------------------------|------------------|------------------|
| Comando único | 06 | NC36/06 | RF36/06 | 401 | 461 |
| | 07 | NC36/07 | RF36/07 | 461 | 521 |
| | 08 | NC36/08 | RF36/08 | 521 | 581 |
| | 09 | NC36/09 | RF36/09 | 581 | 641 |
| | 10 | NC36/10 | RF36/10 | 641 | 701 |
| | 11 | NC36/11 | RF36/11 | 701 | 761 |
| | 12 | NC36/12 | RF36/12 | 761 | 821 |
| | 13 | NC36/13 | RF36/13 | 821 | 881 |
| | 14 | NC36/14 | RF36/14 | 881 | 941 |
| | 15 | NC36/15 | RF36/15 | 941 | 1001 |
| | 16 | NC36/16 | RF36/16 | 1001 | 1061 |
| | 17 | NC36/17 | RF36/17 | 1061 | 1121 |
| | 18 | NC36/18 | RF36/18 | 1121 | 1181 |
| | 19 | NC36/19 | RF36/19 | 1181 | 1241 |
| | 20 | NC36/20 | RF36/20 | 1241 | 1301 |
| | 21 | NC36/21 | RF36/21 | 1301 | 1361 |
| | 22 | NC36/22 | RF36/22 | 1361 | 1421 |
| Comando doble | 23 | NC36/23 | RF36/23 | 1421 | 1481 |
| | 24 | NC36/24 | RF36/24 | 1481 | 1541 |
| | 25 | NC36/25 | RF36/25 | 1541 | 1601 |
| | 26 | NC36/26 | RF36/26 | 1601 | 1661 |
| | 27 | NC36/27 | RF36/27 | 1661 | 1721 |
| | 28 | NC36/28 | RF36/28 | 1721 | 1781 |
| | 29 | NC36/29 | RF36/29 | 1781 | 1841 |
| | 30 | NC36/30 | RF36/30 | 1841 | 1901 |
| | 31 | NC36/31 | RF36/31 | 1901 | 1961 |
| | 32 | NC36/32 | RF36/32 | 1961 | 2021 |

