



**provedal**







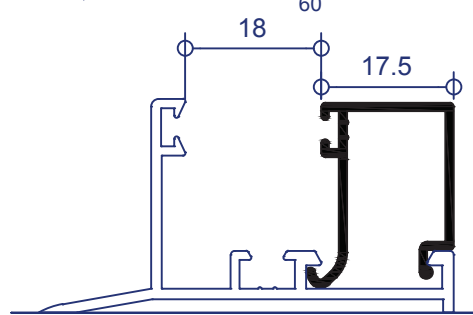
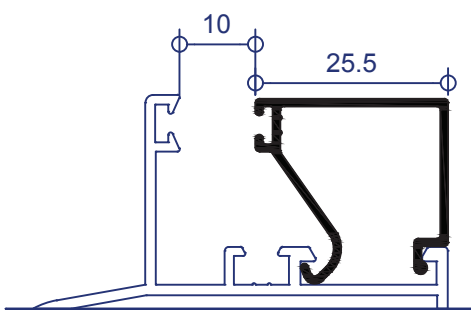
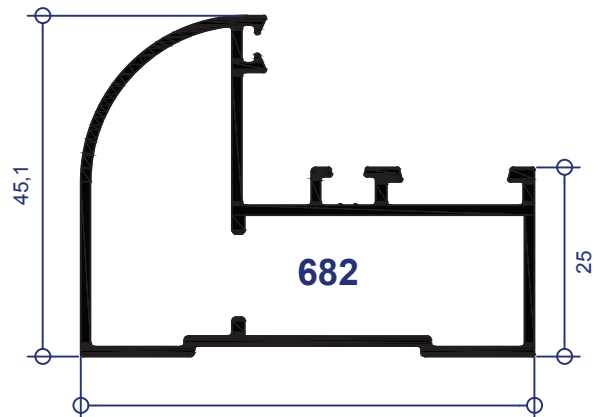
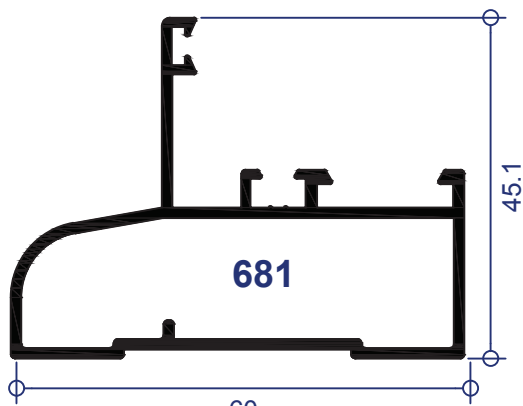
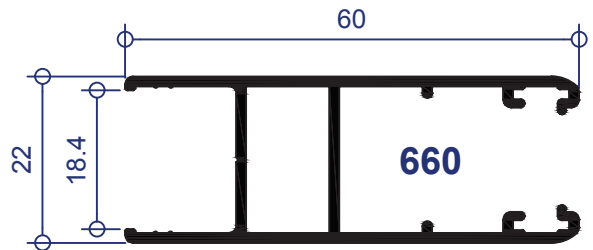
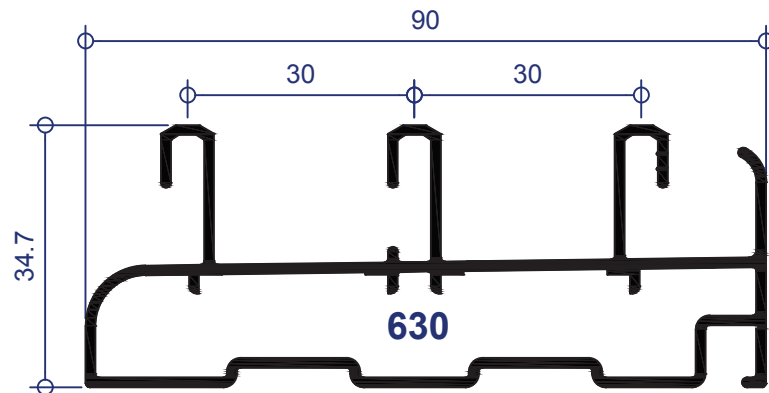
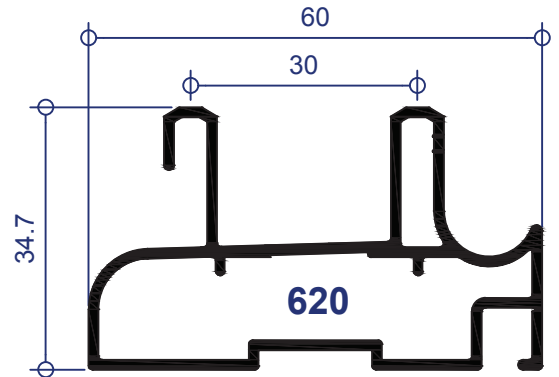
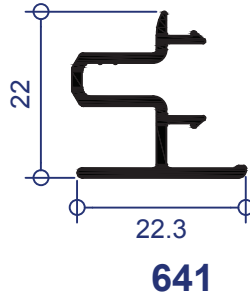
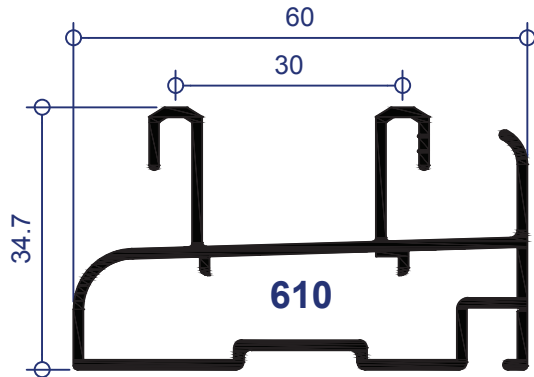
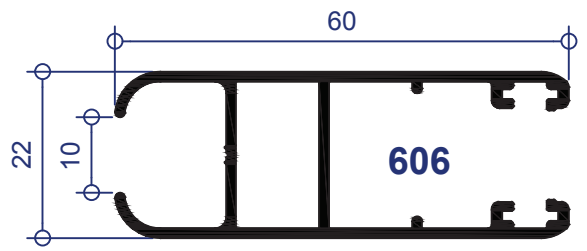
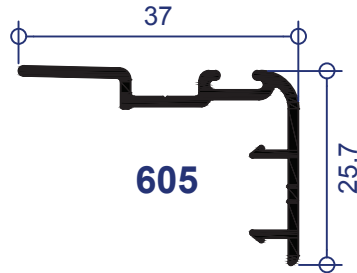
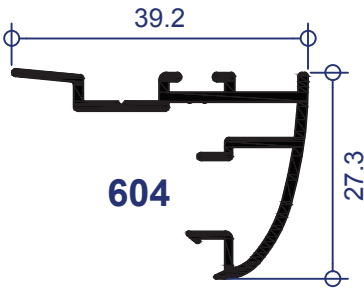

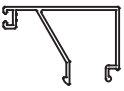
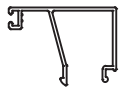
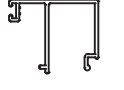
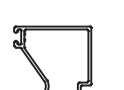
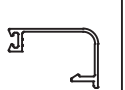

**corredera C-60**

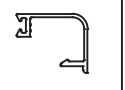
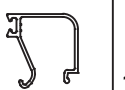
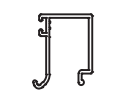

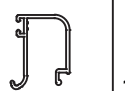
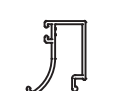
**sopena**  
SISTEMAS



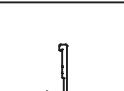

REFERENCIAS			A	B	C	D	F
			mm	mm	mm	mm	mm
			--	3	23	8	12
980301							
			--	6	26	11	15
980302							
			6	12	22	17	21
940300							
			10	16	36	21	25
940306	940310	940320					
			12	18	38	23	27
940301	940311	940321					
			18	24	44	29	33
940302	940312	940322					
			22	28	48	33	37
940303	940313	940323					
			26	32	52	37	41
940304	940314	940324					
			33	39	59	44	48
940305							

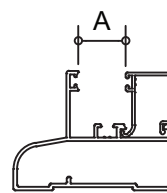

C-60

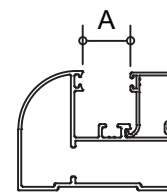

C-60

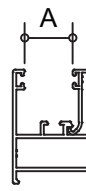

V-94

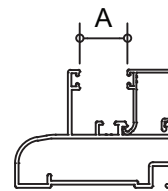

V-94

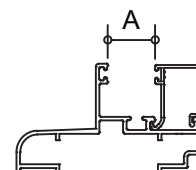

C-70

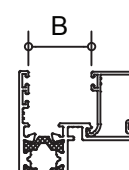

V-98 RT

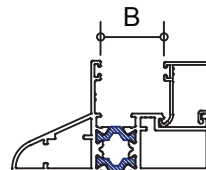

C-75 RT

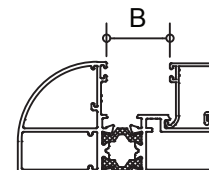

C-75 RT

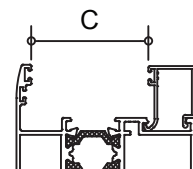

V-98/67 RT

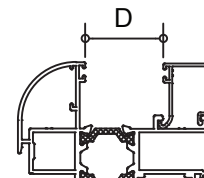

V-98/67 RT

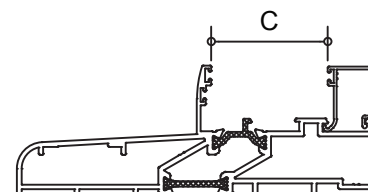

ELV-135 RT

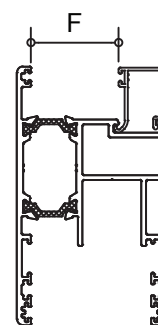

ELV-135 RT